



Operator Manual

iCLASS FP



 Get the app & manual



DOT – PUBLIC USE LIFT
SWL 1000lbs

DOT-Public Use Lift verifies that this platform lift meets the Public Use Lift requirements of FMVSS No. 403. This lift may be installed on all vehicles appropriate for the size and weight of the lift, but must be installed on buses, school buses, and multi-purpose passenger vehicles other than motor homes with a gross vehicle weight rating (GVWR) that exceeds (4,536 kg) 10,000 lb.

Revision Status

REVISION	DATE	NOTE
0	MARCH 2020	ORIGINAL VERSION
1	JULY 2020	CONTENT UPDATE

Warnings	4
Lift and Vehicle Safety	5
1 Introduction	6
1.2 Know your lift.....	7
1.3 Lift Terminology	8
1.4 iCLASS FP - STOWED.....	9
1.4 Power Pack.....	10
1.5 Technical Specification	11
1.6 ID Plate.....	11
2 Lift Safety and Operation	12
2.1 Safety Devices	15
3 Standard Operation	17
3.1 Lift Handle Safety Belt	20
4 Emergency Operation	20
5 Smart Lift App	22
6 Maintenance Schedule	23
6.1 Daily Checks	23
6.2 Checks to be performed every two weeks	25
6.3 Service Type A.....	26
6.4 Service Type B.....	27
6.5 Service Type C.....	29
6.6 Service Type D.....	29
6.7 Hydraulic Oil Level -check and top-up	30
6.8 Lift Labels	31
6.9 Power Pack Labels - Outside	32
6.10 Power Pack Labels - Inside.....	33

Mobility Networks refuses all responsibility for damages caused by:

- Improper use of the hydraulic lift.
- Platform overloading.
- A failure in carrying out “use and maintenance” manual instructions.
- A failure in carrying out maintenance operation as detailed in the “use and maintenance” manual.
- Interventions or modifications to the lift without Mobility Networks authorization.



WARNING

Non-fulfilment of the manufacturer’s specified regular inspection dates may affect or even void the product warranty.

Before operating tail lift:

- Park the vehicle on level ground, Ensure the platform is horizontal (not more than 5°) see Rear and Side View
- NEVER leave the lift unattended at ground level if passengers are onboard.
- When the lift is not in use controls should be deactivated.
- Ensure that the lift is correctly stowed after loading.

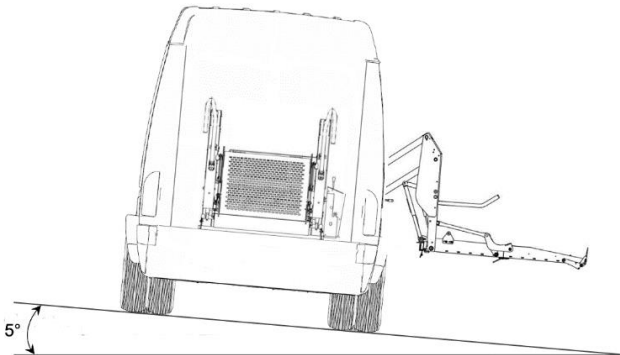

Rear View

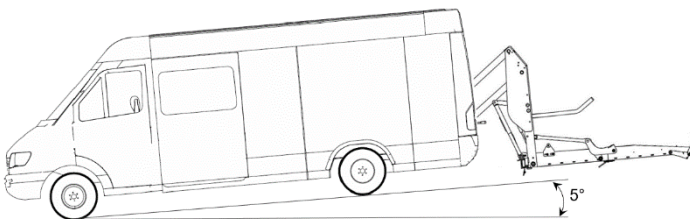

Side View

iCLASS FP, with a folded platform deployed automatically during the opening phase and folds automatically during stowing in order to reduce the overall height of the lift at rest resulting in improved rear visibility for the driver of the vehicle. Handle Safety Belt is standard.



The iCLASS lift is installed on the deck of vehicles used for transporting persons with reduced mobility (PRM) in wheelchairs, allowing them to get into and out of the vehicle.

The lift consists of a base fixed to the vehicle loading deck, a pair of outer lifting arms installed on the sides of the base, and a loading platform, hinged between these.

Deploying/stowing and lifting/lowering movements of the lift are made by means of a parallelogram leverage mechanism driven by a pair of hydraulic cylinders (one for each outer arm).

The machine is equipped with a hydraulic control unit and an electronic control box – the Power Pack - which by means of a remote control performs the various functional movements. The entire system is electrically powered by the batteries of the vehicle.

The iCLASS lift is designed To Transport:

	<p>One person in a wheelchair with or without an attendant, with a size not larger than the width/ length of platform space available, or weight over the stated SWL capacity.</p>
<p>Or:</p>	
	<p>Two walking passengers. The operator should not attempt to transport more than two people at a time because of increased risk of passenger discomfort. The passengers also may require extra space for mobility devices such as sticks and frames.</p>
	<p>WARNING The Operator must perform their proper hazard assessment and define the best practice for boarding and alighting the vehicle and lift.</p>

1.2 Know your lift

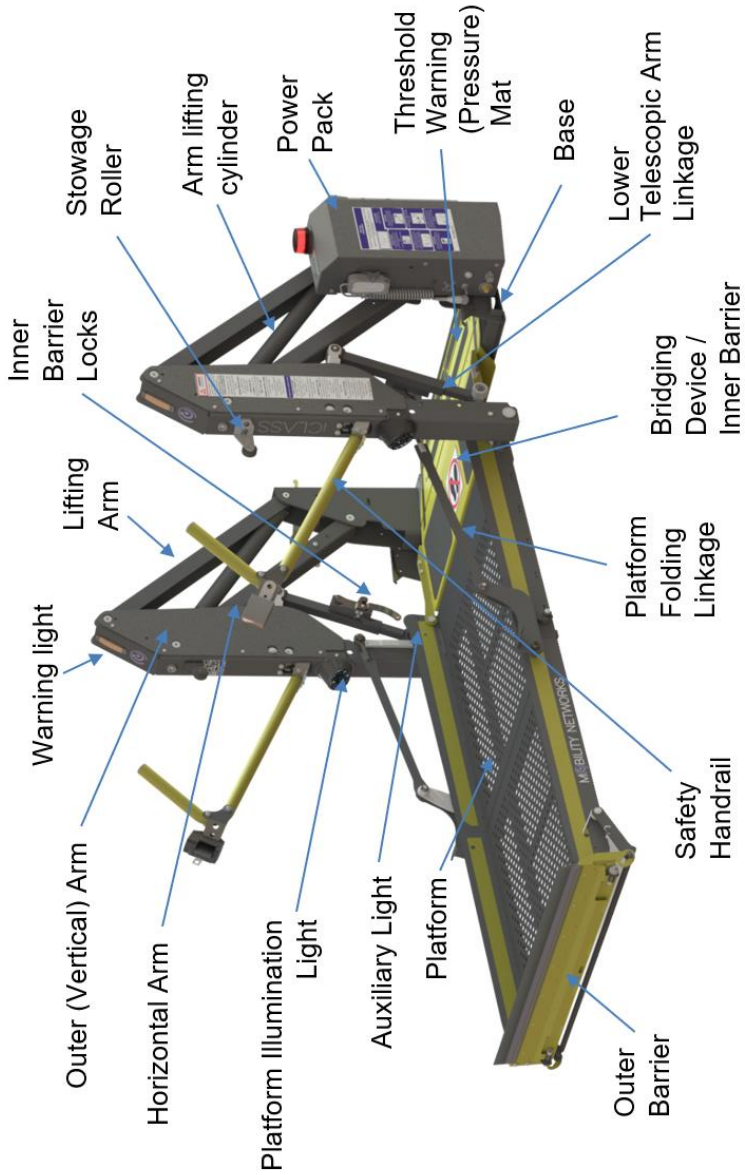

1.3 Lift Terminology

Base: Fixes the lift to the floor of the vehicle

Inner Barrier Locks: Secure the inner barrier in the upright position

Arm Lifting Cylinder: Fitted to both sides of the lift, provides the hydraulic power to raise the lift

Power Pack: Electro-Hydraulic power and 'brain' for the lift

Threshold Warning Mat: senses when the transition from vehicle to lift or lift to vehicle takes place and gives an optical and audible warning

Lower Telescopic Arm linkage, horizontal arm, vertical arm, lifting arm: are the main parallelogram links that join the base to the platform and allows the lift to raise and lower

Bridging Device / Inner barrier: Portion of the platform lift that provides a transitional surface between the platform surface and the surface of the vehicle floor within the platform threshold area. Designed to retain mobility aids on the platform surface during the range of passenger operation

Safety Handrails: To ensure a 'firm hold' during the lifting / lowering phase

Outer barrier: Wheelchair retention device that is located on the edge of the platform, is traversed during ground level loading and unloading, and is designed to retain wheelchairs on the platform surface during the range of passenger operation

Outer barrier cylinder: operates the outer barrier

Platform: is made from durable steel mesh which is both anti-slip and weather proof

Auxiliary and Platform Illumination ('Frog') Lights: illuminate the platform from both sides of the lift during use

Warning lights: flash when power is on to indicate the lift is in use

Lift Terminology - continued

Directions Left, Right are those when viewing the vehicle from the rear

Inboard is into the vehicle or toward the centre of the lift

Outboard is out of the vehicle or from the centre of the lift outwards sideways.

Lift States:

- **Stowed** (Lift is closed and parked vertically in the vehicle with safety hook latched)
- **Stowing** (Between Deployed and Stowed)
- **Deploying** (From Stowed to Deployed)
- **Deployed** (Lift is at floor level in the vehicle. When Deploying or Lifting, the lift will stop automatically at floor level)
- **Lowering** (Between Deployed and lowered)
- **Lowered** (Lift is at ground level outside of the vehicle. When lowering, the lift will automatically stop when ground level is reached)
- **Lifting** (Between lowered and deployed)

1.4 iCLASS FP - STOWED

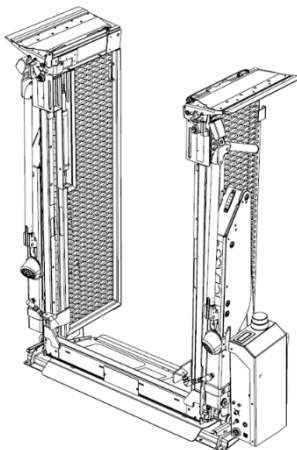

1.4 Power Pack

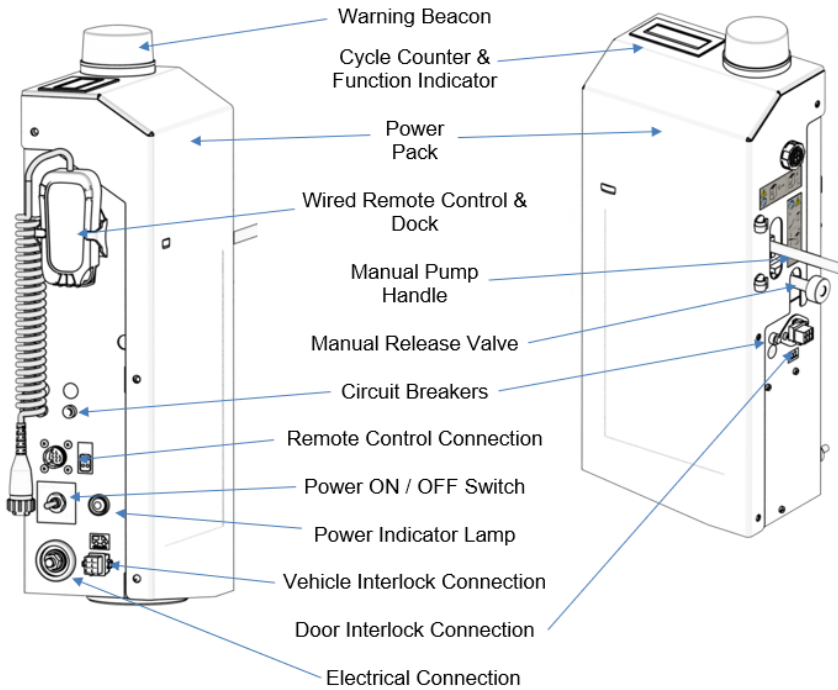

Connections are fitted to the outside of the powerpack making for quicker installation and easier maintenance

1.5 Technical Specification

Supply Voltage	12 V / 24 V (option)
Electric motor power	500W
Maximum hydraulic system pressure	130 bar (1885 psi)
Oil tank capacity	iCLASS FP: 1.0 l (0.26 Gal (US))
Safe Working Limit (uniformly distributed)	455kg (1000lb)
Maximum height reached (dependent on model)	0.79 - 1.22 m (31 - 48")
Total mass of the lift (dependent on options fitted)	125 - 160 kg (275 - 352lb)
Manual auxiliary hand pump	Included in Power Pack
Hydraulic oil (relevant to local environment)	15w – 32w (ATF type not recommended)
Sound Pressure (Normal) With audible warning	<70 dB >90 dB
Gas Spring operating temperature	-30°C to 80°C

1.6 ID Plate

Is on the inboard side of the lift tower. Record the information below. The Serial Number is required for service and warranty.

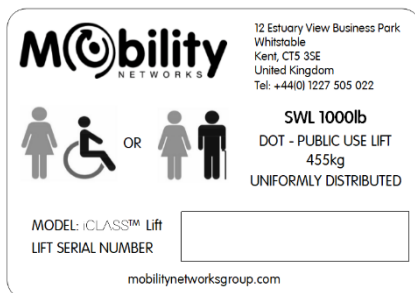

Installer
Installation Date
Serial Number

Before operating tail lift:

Fully familiarize yourself with lift controls, relevant safety procedures and possible hazards signified by warning labels or highlighted in your Operator Hazard Assessment.

Lift safety:

Only an authorized fully trained operator must control the lift.

Secure vehicle doors fully open, well clear of the lift platform.

Keep within the stated maximum safe working load (SWL).

Keep people away from the operating area (inside and outside the vehicle).

Ensure the platform is always level (horizontal, not more than 5°).

NEVER leave the lift unattended at ground level if passengers are onboard.

When the lift is not in use controls should be deactivated.

Ensure that the lift is correctly stowed after loading.

Operators ensure that:

Lift will lower to firm, level ground

Scooter or powered wheelchair is not larger than the lift platform in any direction

The lift is in a FULLY operational condition. Report any defects.

Lift Inner Barrier / Bridging Device lands flat onto vehicle floor.

Lift Outer Barrier is set vertically (minimum 80°) and fully operational.

Accompany the passenger on the lift is possible, but do not overload the lift.

You have a clear view of the lift platform before the passenger moves onto it.

NEVER leave passengers unattended at any time.

The passenger should not be required to operate ANY controls.

Loading and Unloading procedure:

Explain to passenger the sequence of movements that will occur.

Where possible passenger should dismount the scooter / wheelchair and board the vehicle separately. Wheelchair user should point away from the Vehicle for loading and unloading. Connect (Buckle) the handlebar seatbelt (if fitted) as shown in Figure 2.1

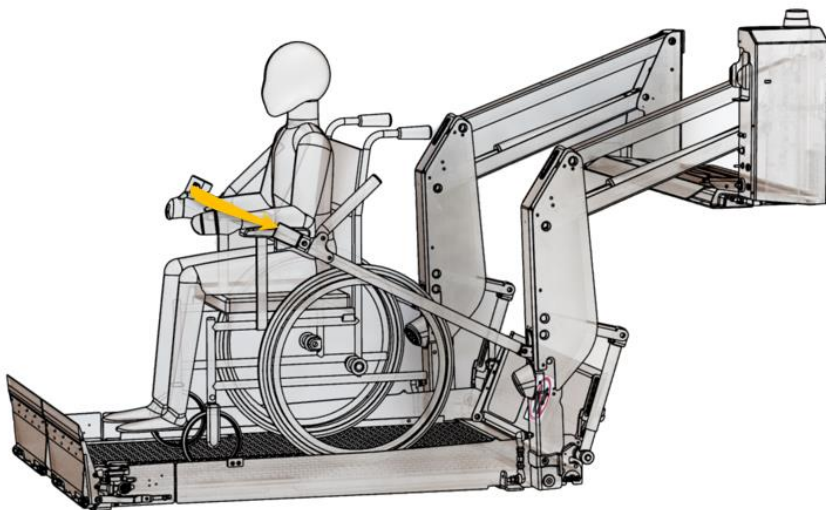

Above: Figure 2.1

Note: Ensure seatbelt is snug to the occupant, as low on the abdomen / leg intersection as possible.

Ensure the

lift platform and area around the lift are free from obstruction.

Ensure the lift platform is in the correct position before moving onto it.

Scooter / Powered Wheelchair should be pushed onto the lift platform, NOT DRIVEN.



Ensure that persons or equipment do not overhang the platform. BEFORE the lift begins motion Scooter / Wheelchair brakes to be applied (or wheels blocked). Wheelchair integrated occupant seatbelts should be used.

All power to the scooter / powered wheelchair is turned OFF.

Operate lift platform to the vehicle floor.

Scooter / Wheelchair should be pushed off the lift platform, NOT DRIVEN

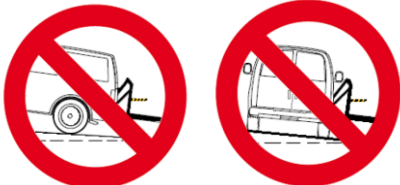
Scooter / Wheelchair and passenger should be restrained in the vehicle using the correct the correct equipment. (Wheelchair Tiedown and Occupant Restraint System, WTORS).

<p>Stand clear of lift when in operation and keep bystanders away</p>	
<p>Park on level ground with plenty of maneuvering space around the vehicle</p>	
<p>The disabled person must always face away from the vehicle the vehicle. Do not approach the vehicle threshold with your back to it. Make sure the platform is in position before leaving the vehicle</p>	
<p>Do not remain stood on the inner barrier / threshold plate when lowering or stowing the lift. Do not push against it during use.</p>	

2.1 Safety Devices

Safety handrails:

To ensure a 'firm hold' during the lifting / lowering phase.

Handrail Safety Belt:

For lift operation maneuvers the seatbelt helps retain the lift user on the platform.

Bridging Device / Inner Barrier or Inner Roll Stop:

Portion of the platform lift that provides a transitional surface between the platform surface and the surface of the vehicle floor within the platform threshold area.

Designed to retain mobility aids on the platform surface during the range of passenger operation.

Outer Barrier:

Wheelchair retention device that is located on the edge of the platform, is traversed during ground level loading and unloading, and is designed to retain wheelchairs on the platform surface during the range of passenger operation.

Guarding:

Covers are present on moving parts.

Threshold warning Public-use lift:

An audible warning **and** flashing red visual warning beacon will activate.

Protection against overturning:

Stops platform lowering in case of an obstacle which could induce overturning.

Safety pressure switch:

Prevents stowing when platform is still loaded.

Protection against overloading:

Prevents overload of the nominal loading capability of the lift.

Protection against hydraulic system leakage:

Maximum speed 150mm/s, typically 75mm/s. Hoses tested to over 4x max pressure value.

Safety Lock:

Prevents the unintentional opening of the platform in case of low hydraulic system pressure when the lift is closed.

Inner Barrier Lock:

Automatically locks inner barrier in place during lowering, deployed and lifting phases.

External signaling:

In addition to the warning beacon, amber warning lights are fitted on each outer arm.

Lighting Requirement:

The iCLASS lift has auxiliary platform lighting fitted on each outer arm. The vehicle should also be fitted with additional loading door illumination.

It is recommended that the iCLASS lift is used in conjunction with the Inboard Lift DoorSafe, as shown in Figure 2.1 below.

The Inboard Lift DoorSafe has been specifically engineered to act as a fixed, strong, physical barrier, used to protect passengers when the rear doors to a vehicle are open. LED lights and clear warnings give operators peace of mind that passengers are safe at all times. LED lights are an optional extra with the Inboard Lift DoorSafe barrier. The Inboard Lift DoorSafe is an automatic barrier with a manual override option. The manual override allows the barrier to be moved up and down in case sudden access is needed.



In a safe area, park the vehicle on level ground, make sure there is enough room around the vehicle to enable safe operation. Open door(s) and secure fully open.

If automatic doors are fitted, refer to those instructions.



WARNING

Make sure that the relative movement of the platform corresponds to each command without jamming and unusual noises.

STOP AND CHECK!

Power On:

- Toggle UP the **LIFT POWER** switch to the **ON** Position

The passenger compartment warning light confirms power to the lift is enabled.

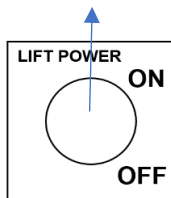

Above: Figure 3.1 Power On

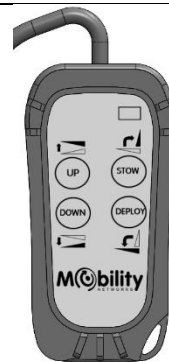

Above: Figure 3.2 Remote Control

Opening is a rotational movement that moves the loading platform from the vertical (closed) position to the horizontal loading position at vehicle floor level.

- Operator **MUST** stand clear of deploying lift.
- Push and hold **DEPLOY** (Figure 3.2) button until platform stops at the horizontal loading position on the floor of the vehicle).
- Release button.

- Buckle Lift Handle Seatbelt. The platform can now be loaded.

 **WARNING**

Once the user is on the platform or before starting the
lifting/lowering operation:
the wheelchair **MUST BE braked**.

- **fit wheelchair occupant seatbelts.**

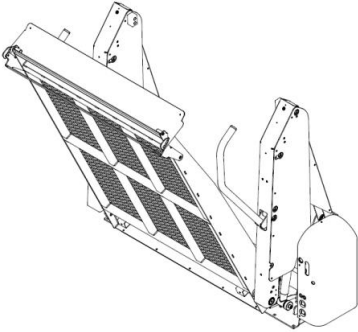

Figure 3.3 Platform deploy

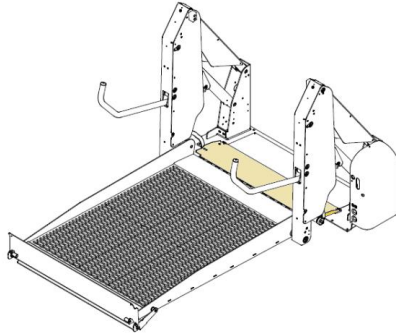

Figure 3.4 Platform at vehicle floor level



Lowering Platform:

- Push and hold **DOWN** (Figure 3.5) button until platform stops at the horizontal loading position on the ground.
- Release button.

Once stopped at ground level, platform is ready to be loaded or unloaded.

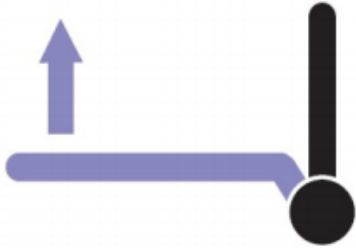

Above: Figure 3.5 DOWN

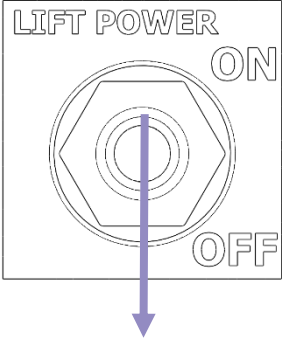
<p>Raising Platform:</p> <ul style="list-style-type: none"> ● Push and hold UP (Figure 3.2) button until platform stops at the horizontal loading position on the floor of the vehicle. ● Release button. At this point the platform can be unloaded. 	
<p>Stowing the Platform:</p> <p>After making sure that no object has been left on the loading platform, proceed as follows for the closing maneuver:</p> <p>Stowing is a rotational movement that moves the loading platform from the horizontal position to the vertical (closed) position at vehicle floor level.</p> <ul style="list-style-type: none"> ● Push and hold STOW (Fig 3.2) button until platform stops at the vertical loading position on the floor of the vehicle. Keep pressing until the power is interrupted. ● Release button. 	
<p>Power Off:</p> <ul style="list-style-type: none"> ● Toggle DOWN the LIFT POWER switch to OFF ● The passenger compartment warning light extinguishes to confirm lift power is disabled. <p> WARNING</p> <p>To avoid draining the batteries of the vehicle, remember to disable the system after each use of the lift.</p>	

3.1 Lift Handle Safety Belt



WARNING

THIS SECTION PROVIDES ADDITIONAL INFORMATION FOR LIFT HANDLE SAFETY BELT USAGE. THEY **MUST BE USED IN ADDITION TO OTHER INSTUCTIONS IN THIS MANUAL AND IN OPERATOR'S OWN HAZARD ASSESSMENT**

From Stowed Position:	From Ground Level:
Open lift to vehicle floor level	Lift raises only with seatbelt connected – with or without occupant! Move occupant into vehicle
Buckle Lift Handle Safety Belt Lift lowers only with safety belt connected – with or without occupant! Lower to ground level Un-buckle Lift Handle Safety Belt	Disconnect Safety Belt Lift can now be Stowed





4 Emergency Operation

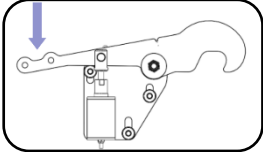
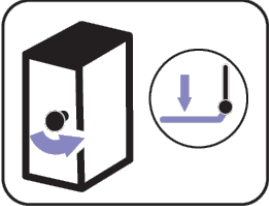
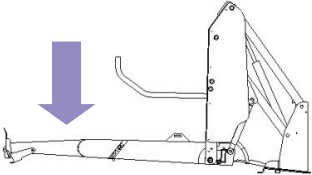

WARNING

- Emergency manual controls are to be used to operate the lift in case of power supply failure. They are not intended for 'normal' use as an alternative to powered operation.
- Emergency manual controls must be exclusively used to help the user during lifting/lowering onto / off the vehicle and to close the opened lift, allowing to the vehicle to start again.

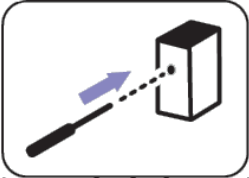
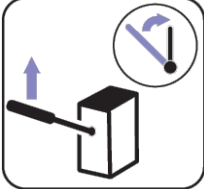
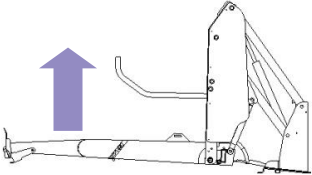
A complete Emergency Operation cycle is as follows:	
<p> DANGER</p> <p>STAND CLEAR OF LIFT RELEASE SAFETY HOOK</p>	
<p>DEPLOY/DOWN</p> <p>On the hydraulic unit, turn the manual override valve counterclockwise (Max 1/4 turn) lowering using the black knob (marked by its relevant label).</p>	
<p>The platform will open and will descend until making contact with the ground or if the lowering valve is closed (by turning the knob clockwise).</p>	
<p>IMPORTANT</p> <p>Before any other operation, close the lowering valve, by turning its knob clockwise.</p>	
<p>UP/STOW</p> <p>Tighten the lever, into the threaded hole. (inside the vertical slot marked by the relevant label)</p>	
<p>Operate the pump manually alternating up / down vertical movements.</p>	
<p>The platform will reach vehicle floor level to allow user on / off the platform. Continue to operate the pump to stow the platform.</p>	

Lift functionality can be achieved wirelessly.

The lift can be controlled / programmed using the **Mobility Networks – Smart Lift App**.

(Download using the QR Code on front of manual / on the lift).

To pair:

On your mobile device, open the application and follow the instructions on the screen. For both iOS / Android the app will ask for Bluetooth and Location settings to be turned on – otherwise the app cannot be used and it will close



Connectivity works in the 3m (10') zone shown in Figure 5.1 below

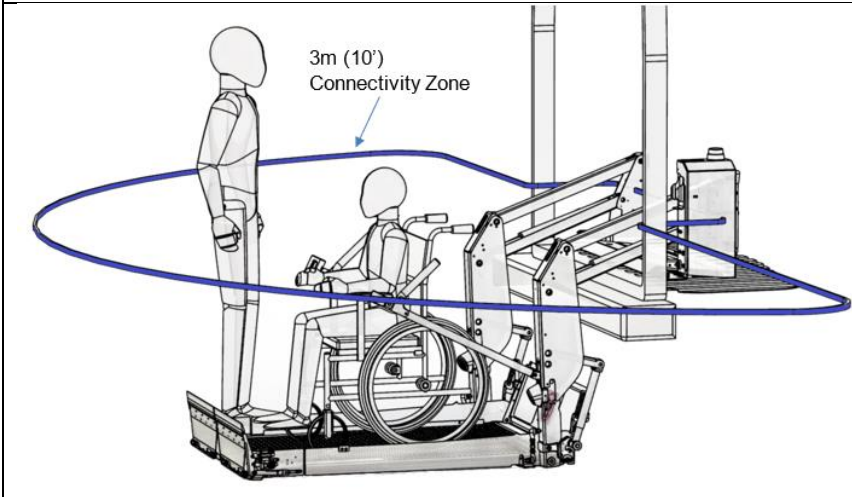

You can operate your iCLASS lift from a distance and receive real time diagnostic information using the App.

Go to mobilitynetworksgroup.com/app for more information and detailed download and installation instructions

Service Interval	Service Type	Complete Service Schedule for 4000 cycles or 12 months (whichever comes first)
Daily	Daily	
2 Weeks	2 Weeks	
1000 cycles (or 3 months - whichever first)	A	
2000 cycles (or 6 months - whichever first)	B	
3000 cycles (or 9 months - whichever first)	A	
4000 cycles (or 12 months - whichever first)	C	
8000 cycles (or 24 months - whichever first)	D	

6.1 Daily Checks

Lift Inspection checks are required on a DAILY basis by the lift operating company.

The working life of the lift will be greatly prolonged if these steps are adhered to:

Daily Inspection Check List	Date:
Lift	
Vehicle #	
Engineer's Name:	
Customer Name:	
Customer Address:	
Phone #	

Check	OK ?
Visually Check Condition of Safety Belt. Deploy all webbing, check both sides and that stitching is in good condition (if fitted)	YES / NO
Visually with the lift stowed, check hydraulic fluid level	YES / NO
Visually check for any leaks or damage	YES / NO
Check for obvious signs of damage, and notify manager if necessary	YES / NO
Operation instruction labels are visible?	YES / NO
Check the hand pump handle is present	YES / NO
Handset control is working correctly and no signs of damage?	YES / NO
Platform is clean and dry?	YES / NO
Ensure the Handrail guards are present and undamaged	YES / NO
Check correct operation of Bridging Device / Inner Roll Stop	YES / NO
Check correct operation of Outer Barrier	YES / NO
Check warning lights are operating correctly	YES / NO

6.2 Checks to be performed every two weeks

Perform the following checks every 2 Weeks:

As Daily Checks plus:

Check	OK ?
Lubricate relevant parts with ACF-50	YES / NO
Check under the vehicle for damage and / or corrosion and that all fasteners are present and tight	YES / NO
Lubricate relevant parts with ACF-50	YES / NO
Check that the vehicle interlock operates correctly – the lift cannot move out of stow position unless the interlock is operational	YES / NO
Check that the bridge plate warning system operates when it is occupied	YES / NO
Check that the outer barrier operates correctly when occupied	YES / NO
Check correct operation of emergency (manual) pump	YES / NO
With the lift is on the ground check that the oil level has not dropped, if so, check system for leaks and make necessary repairs.	YES / NO

6.3 Service Type A

Regular lift maintenance is recommended at the time or the cycles specified in 6.1 by the lift operating company. The working life of your lift will be greatly prolonged if these steps are adhered to.

This should include the following:

Visually Check Condition of Safety Belt. Deploy all webbing, check both sides and that stitching is in good condition (if fitted)

Check for obvious signs of damage and corrosion, replace parts as necessary.

Check the operation and stowing of the lift.

Check the rear roll-off-ramp operation. Lubricate with silicone spray.

Check bridging plate operates correctly, adjust as necessary.

Check handrail operation and security. If components are corroded, they should be replaced due to potential hazard to users! Check location pivot pins, these should be fully secure.

When cleaning the vehicle wash the working platform of the lift in accordance with instructions in the main manual, Section 13.

Check Up/ Down pump for fluid leaks and loose/ corroded electrics. Top up reservoir (with lift at ground position) with recommended Hydraulic Oil, do NOT overfill. Coat any exposed electrics with dielectric grease (to protect).

Lubricate lift in accordance with instructions in the main manual, Section 14.

IF IN DOUBT, CONTACT THE MANUFACTURER

6.4 Service Type B

Regular lift maintenance is recommended at the time or the cycles specified in 12.1 and records kept.

They are required for warranty claim. Without them the warranty may be void.

For Factory Trained Lift Engineers, As Service Type A checks plus:

Task	Description	Check Box When Completed
1	Check arm pivot pins, bushes, bearings and retaining grub screws, in particular the check the arm pin for wear and that fasteners are secure and torqued correctly.	
2	Check cylinder rod clevis and grub screws.	
3	Check the outer barrier hydraulic cylinder(s). See section 12.7	
4	Check other cylinders for oil leaks. Replace piston seal if excessive oil leaking from the cylinder.	
5	Check electrical cabling for signs of wear, if split or damaged this must be replaced!	
6	Check platform wear strips (on underside of platform extension surface) for wear, or 'fastening protrusion' replace if necessary.	
7	Check bridging plate for correct operation. The bridging plate must land flush with the vehicle floor and NOT form a trip hazard.	
8	Check that the platform does not have a side-to-side 'skew'. If a 'skew' is present the lifting cylinders should be adjusted.	

9	Check that the lift mounting brackets and track bolts are tight / secure and free from damage. Corrosion in this area of the lift is likely to occur, however if in an advanced state, components should be exchanged for new items.	
10	Check manual hand pump operation (see Auxiliary Hand Pump Operation Procedure), lubricate all pivot points. REMEMBER TO RETURN ANY MANUAL OVERRIDE KNOBS TO THEIR CLOSED POSITION.	
11	Check the handset wiring by powering the lift whilst manipulating the cable in any direction.	

The following should be performed during Commissioning and at the Service Type B check:

A - Threshold Warning Mat Adjustment		
Position	5kg – No Sensor Trigger (check box to confirm)	8kg – Sensor Triggers (check box to confirm)
1		
2		
3		
4		
5		
6		
Other Checks		(check box to confirm)
B - Outer Barrier Function Check and Adjustment Performed		
C - Platform Stow Check and Adjustment Performed		
D - Inner Barrier Function Checked and Adjustment Performed		

6.5 Service Type C

Perform the same checks as Service Type A and B plus:

Check Hydraulic Fluid Level, Check the condition of all pins, arms and bearings, gas springs, power cables, fixing to vehicle, decals, anti-skid.

6.6 Service Type D

Replace Arm Pivot Pins

Replace Inner Barrier Locks

Replace Hydraulic Fluid

6.7 Hydraulic Oil Level -check and top-up

With the platform **FULLY STOWED** regularly check that the oil level in the hydraulic oil tank is above the minimum level.

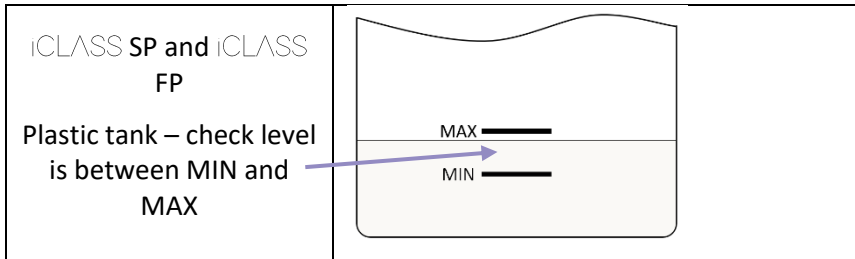

WARNING When the vehicle engine is switched off do not to operate the hydraulic unit for more than one minute to prevent excess drain of batteries.

WARNING When checking and filling/topping up oil, LIFT **MUST** BE **FULLY STOWED**.

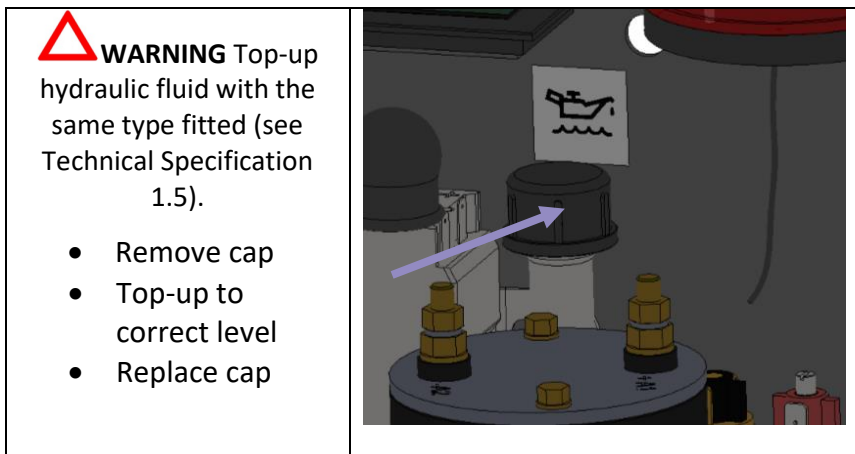

6.8 Lift Labels

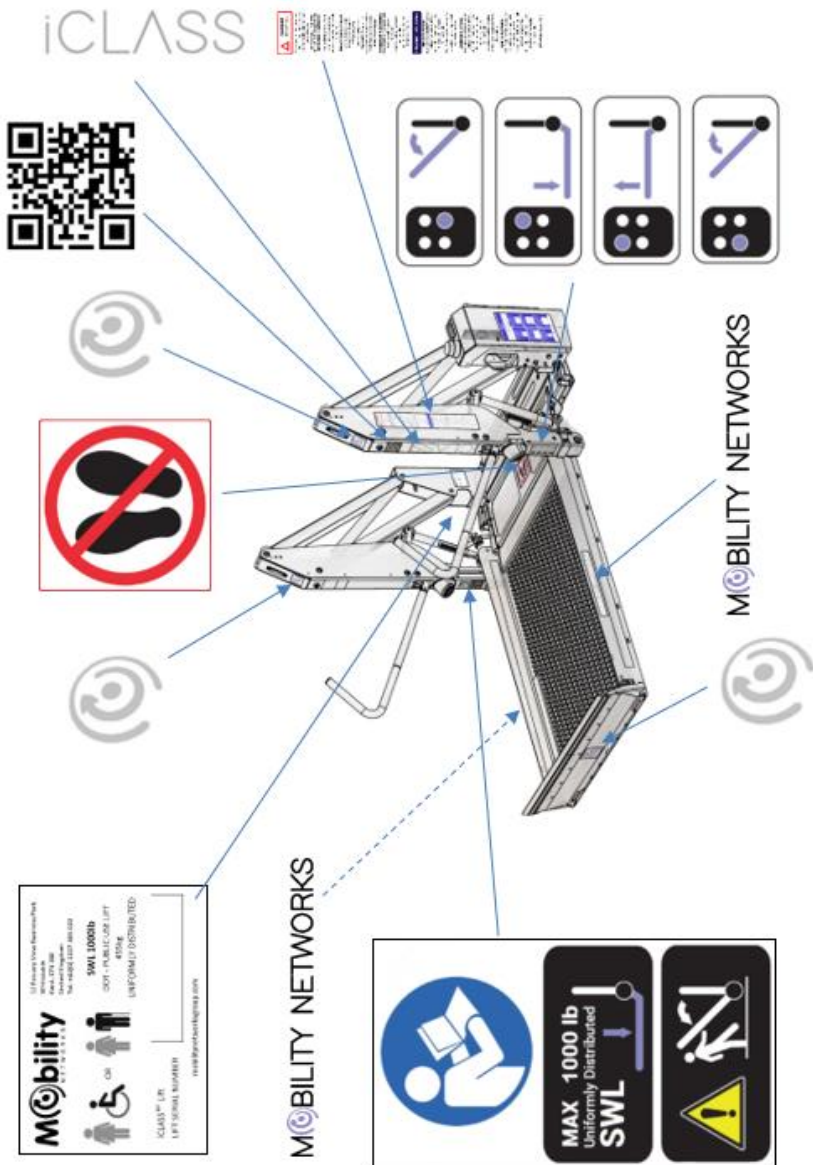

6.9 Power Pack Labels - Outside

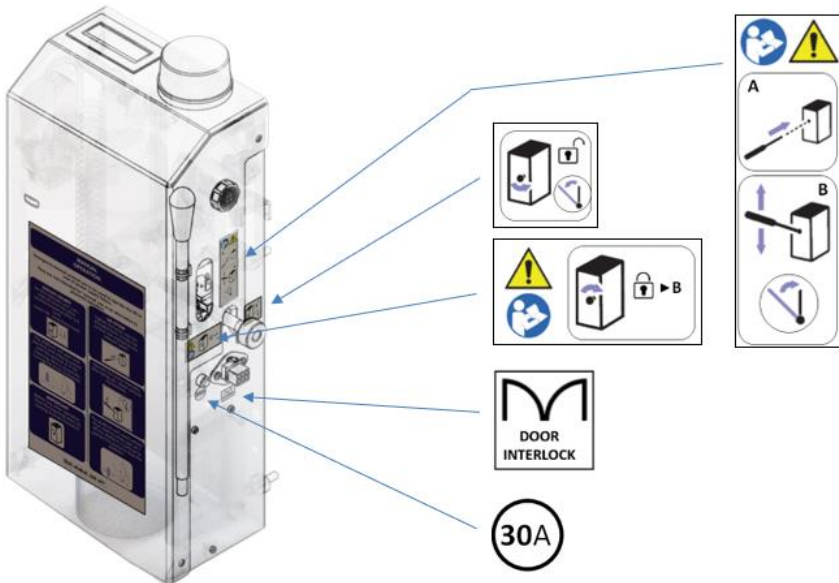
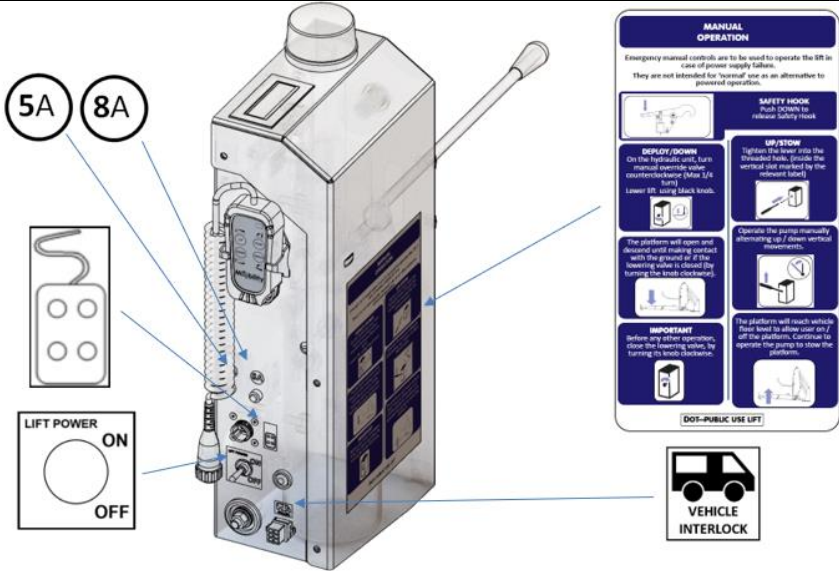

6.10 Power Pack Labels - Inside

